

## FROGMORE PAPER MILL DELIVERED TO YOU

### HISTORY

Curriculum topic - Local Studies KS1

#### TEACHER'S NOTES

On arrival at the mill, papermakers would take a piece of paper and make themselves a hat to wear. This was to keep water drips, spiders and cobwebs from the vat and was a sign of status. A papermaker's hat is not unlike a paper boat to make.

#### TEACHER PREP - **HISTORY DETECTIVES**- papermaker's hat

**30 minute activity**

You will need the following:-



A piece of A2 paper for each hat to be made. As thin as possible to make for easier folding.  
Newsprint is good. Some teaching assistants on hand if possible  
The set of instructions on the memory stick.



## How to make a papermakers hat.

1. fold your sheet of paper in half.

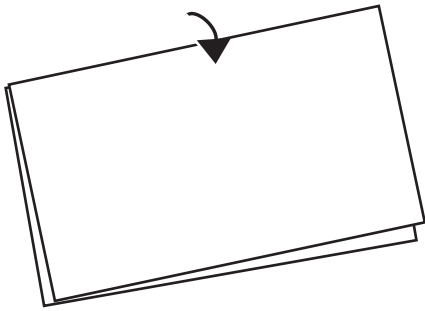

2. fold down corners A and B along the dotted line.

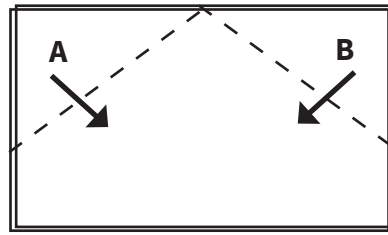

3. using the top layer fold the bottom edge over twice.

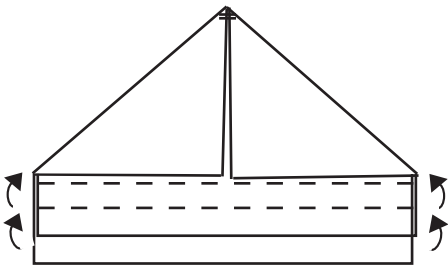

4. turn the hat over.

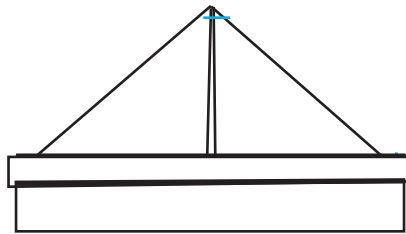

5. fold the sides C and D to the middle along the dotted lines.

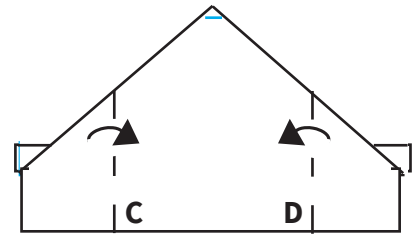

6. fold the bottom corners up to the band.

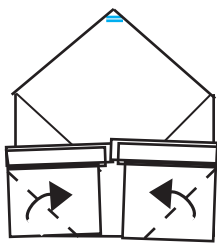

7. fold the bottom flap over the band and tuck it in.

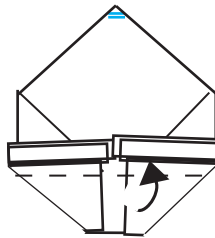

8. fold the top point down and tuck it into the band.

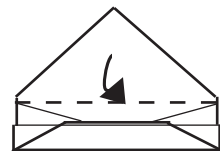

9. pull out the open end and fold the opposite sides together to make a square.

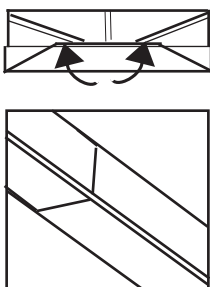

10. fold in the corners and tuck them under the band.

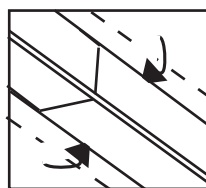

11. open out from the centre.

